

SIRUBA®

銀箭牌工業用縫紉機

INDUSTRIAL SEWING MACHINE

F007K / F007KD F858K / F858KD



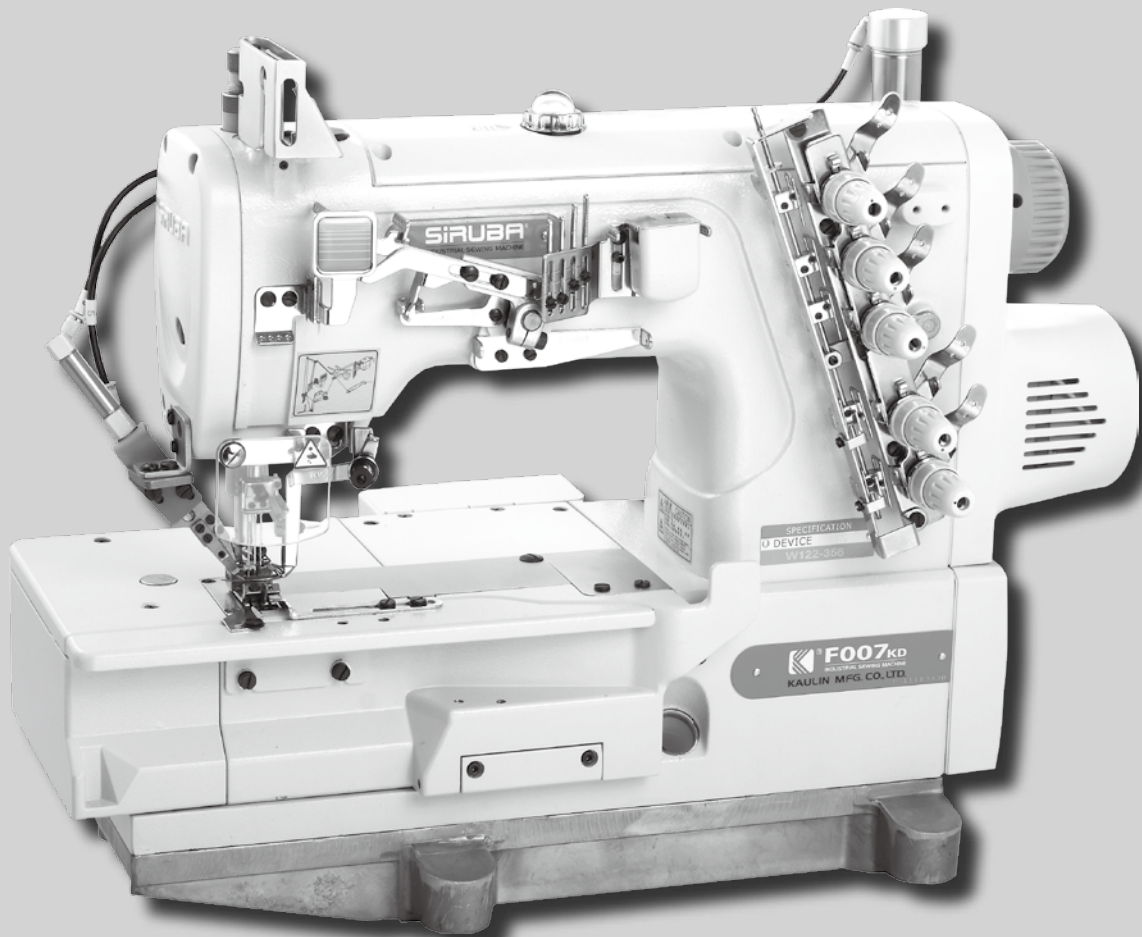





零件圖 PARTS LIST



CE

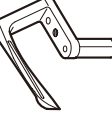
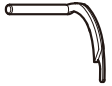

高林股份有限公司
KAULIN MFG. CO., LTD.

									
MODEL	SUB-CLASS	NEEDLE CLAMP	NEEDLE PLATE	MAIN FEED DOG	DIFF. FEED DOG	PRESSER FOOT	LOOPER	SPREADER	NEEDLE
機 型	規 格	針 座	針 板	主送具	差送具	壓 具	勾 針	上 叉	使 用 針
F007K(KD) F858K(KD) /FHA	240	M5240	E1514K	D1206	H1258	P2544K-A	ME28	MH41	UYX128GAS#10
	248	M5248	E1515K	D1207	H1259	P2545K-A	—	—	UYX128GAS#10
	356	M5356	E1816K			P2446K-A			
	364	M5364	E1817K	P2447K-A					
F007K(KD) F858K(KD) /FHA/UTG(UTJ)	240	M5240	E1514K	D1206	H1258	P2544K-A			
	248	M5248	E1515K	D1207	H1259	P2545K-A	—	—	UYX128GAS#10
	356	M5356	E1816K			P2446K-A			
	364	M5364	E1817K	P2447K-A					
F007K(KD) F858K(KD) /FHA/UTH(UTK)	240	M5240	E1514K	D1206	H1258	P2544K-A			
	248	M5248	E1515K	D1207	H1259	P2545K-A	—	—	UYX128GAS#10
	356	M5356	E1816K			P2446K-A			
	364	M5364	E1817K	P2447K-A					
F007K(KD) F858K(KD) /FHA	240	M5240	E1524K	D1206	H1258	P2544K-A			
	248	M5248	E1525K	D1207	H1259	P2545K-A	—	—	UYX128GAS#10
	356	M5356	E1826K			P2446K-A			
	364	M5364	E1827K	P2447K-A					
F007K(KD) F858K(KD) /FHA/UTG(UTJ)	240	M5240	E1524K	D1206	H1258	P2544K-A			
	248	M5248	E1525K	D1207	H1259	P2545K-A	—	—	UYX128GAS#10
	356	M5356	E1826K			P2446K-A			
	364	M5364	E1827K	P2447K-A					
F007K(KD) F858K(KD) /FHA	240	M5240	E1524K	D1206	H1258	P2544K-A			
	248	M5248	E1525K	D1207	H1259	P2545K-A	—	—	UYX128GAS#10
	356	M5356	E1826K			P2446K-A			
	364	M5364	E1827K	P2447K-A					
F007K(KD) F858K(KD) /FHA/UTH(UTK)	240	M5240	E1524K	D1206	H1258	P2544K-A			
	248	M5248	E1525K	D1207	H1259	P2545K-A	—	—	UYX128GAS#10
	356	M5356	E1826K			P2446K-A			
	364	M5364	E1827K	P2447K-A					

規格件表 CONVERSION CHART







規格件表 CONVERSION CHART

MODEL	SUB-CLASS	NEEDLE CLAMP	NEEDLE PLATE	MAIN FEED DOG	DIFF. FEED DOG	PRESSER FOOT	LOOPER	SPREADER	NEEDLE
機 型	規 格	針 座	針 板	主送具	差送具	壓 具	勾 針	上 叉	使 用 針
F007K(KD) F858K(KD) /FP	232	M5232	E1623K	D1206	H1257	P4011K-A	ME28	—	TVX5#14
F007K(KD) F858K(KD) /FHA	240 248 356 364	M5240 M5248 M5356 M5364	E1534K E1535K E1836K E1837K	D1206 D1207	H1258 H1259	P2544K-A P2545K-A P2446K-A P2447K-A	ME28	MH41	UYX128GAS#10
F007K(KD) F858K(KD) /FHA/UTG(UTJ)	240 248 356 364	M5240 M5248 M5356 M5364	E1534K E1535K E1836K E1837K	D1206 D1207	H1258 H1259	P2544K-A P2545K-A P2446K-A P2447K-A	ME28	MH41	UYX128GAS#10
F007K(KD) F858K(KD) /FHA	356 364	M5356 M5364	E1846K E1847K	D1207	H1259	P2446K-A P2447K-A	ME28A	MH41	TV*5#14~16
F007K(KD) F858K(KD) /FHA	356 364	M5356 M5364	E1846K E1847K	D1207	H1259	P2446K-A P2447K-A	ME28A	—	TV*5#14~16
F007K(KD) F858K(KD) /FHA/UTG(UTJ)	356 364	M5356 M5364	E1846K E1847K	D1207	H1259	P2446K-A P2447K-A	ME28A	MH41	TV*5#14~16
F007K(KD) F858K(KD) /FHA/UTH(UTK)	356 364	M5356 M5364	E1846K E1847K	D1207	H1259	P2446K-A P2447K-A	ME28A	—	TV*5#14~16
F007K(KD) F858K(KD) /FQ	232 240 248 356 364	M5232 M5240 M5248 M5356 M5364	E3023K E3024K E3025K E3326K E3327K	D1215 D1215 D1215 D1216 D1216	H1261K H1261K H1261K H1262K H1262K	P1813K-A P1814K-A P1815K-A P2116K-A P2117K-A	ME28	MH41	UYX128GAS#10
F007K(KD) F858K(KD) /FQ	240 248 356 364	M5240 M5248 M5356 M5364	E3024K E3025K E3326K E3327K	D1215 D1216 D1216	H1261K H1261K H1262K	P2314K-A P2315K-A P2616K-A P2617K-A	ME28	—	UYX128GAS#10

MODEL	SUB-CLASS	NEEDLE CLAMP	NEEDLE PLATE	MAIN FEED DOG	DIFF. FEED DOG	PRESSER FOOT	LOOPER	SPREADER	NEEDLE
機 型	規 格	針 座	針 板	主送具	差送具	壓 具	勾 針	上 叉	使 用 針
F007K(KD)-W222 F858K(KD)-U222 /FQ/UTG(UTJ)	240 248 356 364	M5240 M5248 M5356 M5364	E3024K E3025K E3326K E3327K	D1215 D1215 D1216 D1216	H1261K H1261K H1262K H1262K	P1814K-A P1815K-A P2116K-A P2117K-A	ME28	MH41	UYX128GAS#10
F007K(KD)-U222 F858K(KD)-U222 /FQ/UTH(UTK)	240 248 356 364	M5240 M5248 M5356 M5364	E3024K E3025K E3326K E3327K	D1215 D1215 D1216 D1216	H1261K H1261K H1262K H1262K	P1814K-A P1815K-A P2116K-A P2117K-A	ME28	—	UYX128GAS#10
F007K(KD)-W222 F858K(KD)-U222 /FQ/FAC(FEC)	240 248 356 364	M5240 M5248 M5356 M5364	E3024K E3025K E3326K E3327K	D1215 D1215 D1216 D1216	H1261K H1261K H1262K H1262K	P1814K-A P1815K-A P2116K-A P2117K-A	ME28	MH41	UYX128GAS#10
F007K -W222 F858K /FFD(FFP)	240 248 356 364	M5240 M5248 M5356 M5364	E3024K E3025K E3326K E3327K	D1215 D1215 D1216 D1216	H1261K H1261K H1262K H1262K	P1814K-A P1815K-A P2116K-A P2117K-A	ME28	MH41	UYX128GAS#10
F007K -U222 F858K /FFD(FFP)	240 248 356 364	M5240 M5248 M5356 M5364	E3024K E3025K E3326K E3327K	D1215 D1215 D1216 D1216	H1261K H1261K H1262K H1262K	P2314K-A P2315K-A P2616K-A P2617K-A	ME28	—	UYX128GAS#10
F007K -W222 F858K /FFD/FAC(FEC)	240 248 356 364	M5240 M5248 M5356 M5364	E3024K E3025K E3326K E3327K	D1215 D1215 D1216 D1216	H1261K H1261K H1262K H1262K	P1814K-A P1815K-A P2116K-A P2117K-A	ME28	MH41	UYX128GAS#10
F007K -U222 F858K /FFD/FAC(FEC)	240 248 356 364	M5240 M5248 M5356 M5364	E3024K E3025K E3326K E3327K	D1215 D1215 D1216 D1216	H1261K H1261K H1262K H1262K	P2314K-A P2315K-A P2616K-A P2617K-A	ME28	—	UYX128GAS#10
F007K -U222 F858K /FSM	240-4 248-4 364-4	M5240P M5248P M5364P	E3724K E3725K E3727K	D1516	H1262K	P2714K-A P2715K-A P2717K-A	ME28	—	UYX128GAS#10

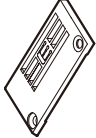
規格件表 CONVERSION CHART

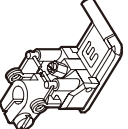
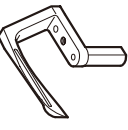
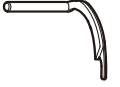







規格件表 CONVERSION CHART







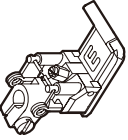
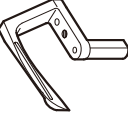
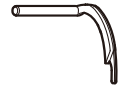



									
MODEL	SUB-CLASS	NEEDLE CLAMP	NEEDLE PLATE	MAIN FEED DOG	DIFF. FEED DOG	PRESSER FOOT	LOOPER	SPREADER	NEEDLE
機 型	規 格	針 座	針 板	主送具	差送具	壓 具	勾 針	上 叉	使 用 針
F007K(KD) F858K(KD) /FDC	356 364	M5356 M5364	E4826K E4827K	D1207	H1359K	P2446K-A P2447K-A	ME28	MH41	UYX128GAS#10
F007K(KD) F858K(KD) /FDC/UTG(UTJ)	356 364	M5356 M5364	E4826K E4827K	D1207	H1359K	P2446K-A P2447K-A	ME28	MH41	UYX128GAS#10
F007K(KD) F858K(KD) /FDC	356 364	M5356 M5364	E4826K E4827K	D1207	H1359K	P2446K-A P2447K-A	ME28	—	UYX128GAS#10
F007K(KD) F858K(KD) /FDC/UTH(UTK)	356 364	M5356 M5364	E4826K E4827K	D1207	H1359K	P2446K-A P2447K-A	ME28	—	UYX128GAS#10
F007K(KD) F858K(KD) /FDE	356 364	M5356 M5364	E4836K E4837K	D1207	H1459-E	P2446K-A P2447K-A	ME28	MH41	UYX128GAS#10
F007K(KD) F858K(KD) /FDE/UTG(UTJ)	356 364	M5356 M5364	E4836K E4837K	D1207	H1459-E	P2446K-A P2447K-A	ME28	MH41	UYX128GAS#10
F007K(KD) F858K(KD) /FDE	356 364	M5356 M5364	E4836K E4837K	D1207	H1459-E	P2446K-A P2447K-A	ME28	—	UYX128GAS#10
F007K(KD) F858K(KD) /FDE/UTH(UTK)	356 364	M5356 M5364	E4836K E4837K	D1207	H1459-E	P2446K-A P2447K-A	ME28	—	UYX128GAS#10
F007K -W512 F858K /FFC(FE)	240 248 356 364	M5240 M5248 M5356 M5364	E1524K E1525K E1826K E1827K	D1206 D1206 D1207 D1207	H1258 H1258 H1259 H1259	P2914K-A P2915K-A P3216K-A P3217K-A	ME28	MH41	UYX128GAS#10

MODEL	SUB-CLASS	NEEDLE CLAMP	NEEDLE PLATE	MAIN FEED DOG	DIFF. FEED DOG	PRESSER FOOT	LOOPER	SPREADER	NEEDLE
機 型	規 格	針 座	針 板	主送具	差送具	壓 具	勾 針	上 叉	使 用 針
F007K-U512 F858K /FFC(FE)	240 248 356 364	M5240 M5248 M5356 M5364	E1524K E1525K E1826K E1827K	D1206 D1206 D1207 D1207	H1258 H1258 H1259 H1259	P3414K-A P3415K-A P3716K-A P3717K-A	ME28	—	UYX128GAS#10
F007K(KD)-W522 F858K(KD) /FR	232 240 248 356 364	M5232 M5240 M5248 M5356 M5364	E6023K E6024K E6025K E6326K E6327K	D2221 D2221 D2221 D2222 D2222	H2267 H2267 H2267 H2268 H2268	P2813K-A P2814K-A P2815K-A P3116K-A P3117K-A	ME28	MH41	UYX128GAS#10
F007K-W522 F858K /FR/FFC(FE)	232 240 248 356 364	M5232 M5240 M5248 M5356 M5364	E6023K E6024K E6025K E6326K E6327K	D2221 D2221 D2221 D2222 D2222	H2267 H2267 H2267 H2268 H2268	P2813K-A P2814K-A P2815K-A P3116K-A P3117K-A	ME28	MH41	UYX128GAS#10
F007K(KD)-U522 F858K(KD) /FR	240 248 356 364	M5240 M5248 M5356 M5364	E6024K E6025K E6326K E6327K	D2221 D2221 D2222 D2222	H2267 H2267 H2268 H2268	P2814K-A P2815K-A P3116K-A P3117K-A	ME28	—	UYX128GAS#10
F007K-U522 F858K /FR/FFC(FE)	240 248 356 364	M5240 M5248 M5356 M5364	E6024K E6025K E6326K E6327K	D2221 D2221 D2222 D2222	H2267 H2267 H2268 H2268	P2814K-A P2815K-A P3116K-A P3117K-A	ME28	—	UYX128GAS#10
F007K-W522 F858K /FR/FFC /FAC(FEC)	240 248 356 364	M5240 M5248 M5356 M5364	E6024K E6025K E6326K E6327K	D2221 D2221 D2222 D2222	H2267 H2267 H2268 H2268	P2814K-A P2815K-A P3116K-A P3117K-A	ME28	—	UYX128GAS#10
F007K(KD)-U613 F858K(KD) /FBP	256 264	M5356 M5364	E1836K E1837K	D1207	H1259	P4000-A P4001-A	ME28	—	TVX5#14~18
F007K(KD)-U712 F858K(KD)	264	M5264	E5827K	D5207	H5259	P5117-A	FS03/04	—	DVX43#11~16

規格件表 CONVERSION CHART

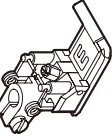
規格件表 CONVERSION CHART

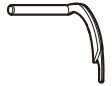
									
MODEL	SUB-CLASS	NEEDLE CLAMP	NEEDLE PLATE	MAIN FEED DOG	DIFF. FEED DOG	PRESSER FOOT	LOOPER	SPREADER	NEEDLE
機型	規格	針座	針板	主送具	差送具	壓具	勾針	上叉	使用針
F007K(KD)-U712 F858K(KD)-U712 /FSP	264	M5264	E5827K	D5207	H5259	P5117-A (成品寬10mm用)	FS03/04	—	DVX43#11~16
F007K(KD)-U712 F858K(KD)-U712 /FSP/FEC	264	M5264	E5827K	D5207	H5259	P5117-A (成品寬10mm用)	FS03/04	—	DVX43#11~16
F007K(KD)-U712 F858K(KD)-U712 /FSR	264	M5264	E5927K	D5307	H5359	P4217-A	FS03/04	—	DVX43#12~14
F007K(KD)-U712 F858K(KD)-U712 /FSP	264	M5264	E5827K	D5207	H5259	P5118-A (成品寬10mm用)	FS03/04	—	DVX43#11~16
F007K(KD)-W722 F858K(KD)-W722 /FY	388	M4388	E6828K	D6207	H6259	P6117-A	FS03/04 /FY02	FY09	TV*7#12
F007K(KD)-W922 F858K(KD)-W922 /FW(FWP)	456 460 464	M5456 M5460 M5464	E1828K E1838K E1848K	D1207P	H1259	P2428Q-A P2438Q-A P2448Q-A	FW28D	MH41	SM1014B#10 (MY1014B#70,
F007K(KD)-W922 F858K(KD)-W922 /FW(FWP)/UTG	456 460 464	M5456 M5460 M5464	E1828K E1838K E1848K	D1207P	H1259	P2428Q-A P2438Q-A P2448Q-A	FW28D	MH41	SM1014B#10 (MY1014B#70,
F007K(KD)-W922 F858K(KD)-W922 /FW(FWP)/UTJ	456 460 464	M5456 M5460 M5464	E1828K E1838K E1848K	D1207P	H1259	P2428Q-A P2438Q-A P2448Q-A	FW28D	MH41	SM1014B#10 (MY1014B#70, SY7256)
F007K(KD)-W923 F858K(KD)-W923 /FW(FWP)	456 460 464	M5456 M5460 M5464	E1828K E1838K E1848K	D1207P	H1259	P2428Q-A P2438Q-A P2448Q-A	FW28D	MH41	SM1014B#10 (MY1014B#70, SY7256)

									
MODEL	SUB-CLASS	NEEDLE CLAMP	NEEDLE PLATE	MAIN FEED DOG	DIFF. FEED DOG	PRESSER FOOT	LOOPER	SPREADER	NEEDLE
機 型	規 格	針 座	針 板	主送具	差送具	壓 具	勾 針	上 叉	使用針
F007K(KD)-W923 F858K(KD) /FW(FWP)/UTG	456 460 464	M5456 M5460 M5464	E1828K E1838K E1848K	D1207P	H1259	P2428Q-A P2438Q-A P2448Q-A	FW28D	MH41	SM1014B#10 (MY1014B#70, SY7256)
F007K(KD)-W923 F858K(KD) /FW(FWP)/UTJ	456 460 464	M5456 M5460 M5464	E1828K E1838K E1848K	D1207P	H1259	P2428Q-A P2438Q-A P2448Q-A	FW28D	MH41	SM1014B#10 (MY1014B#70, SY7256)

PARTS LIST FOR MA GROUP

PARTS LIST FOR MA GROUP

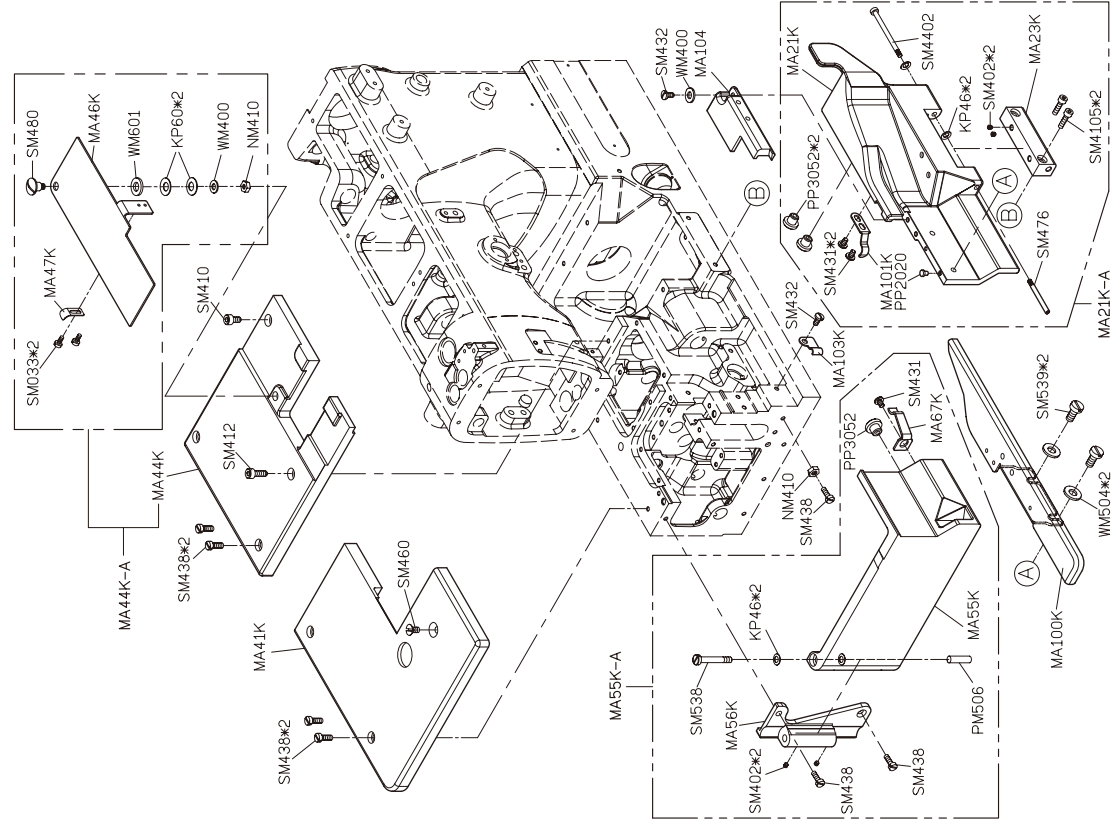
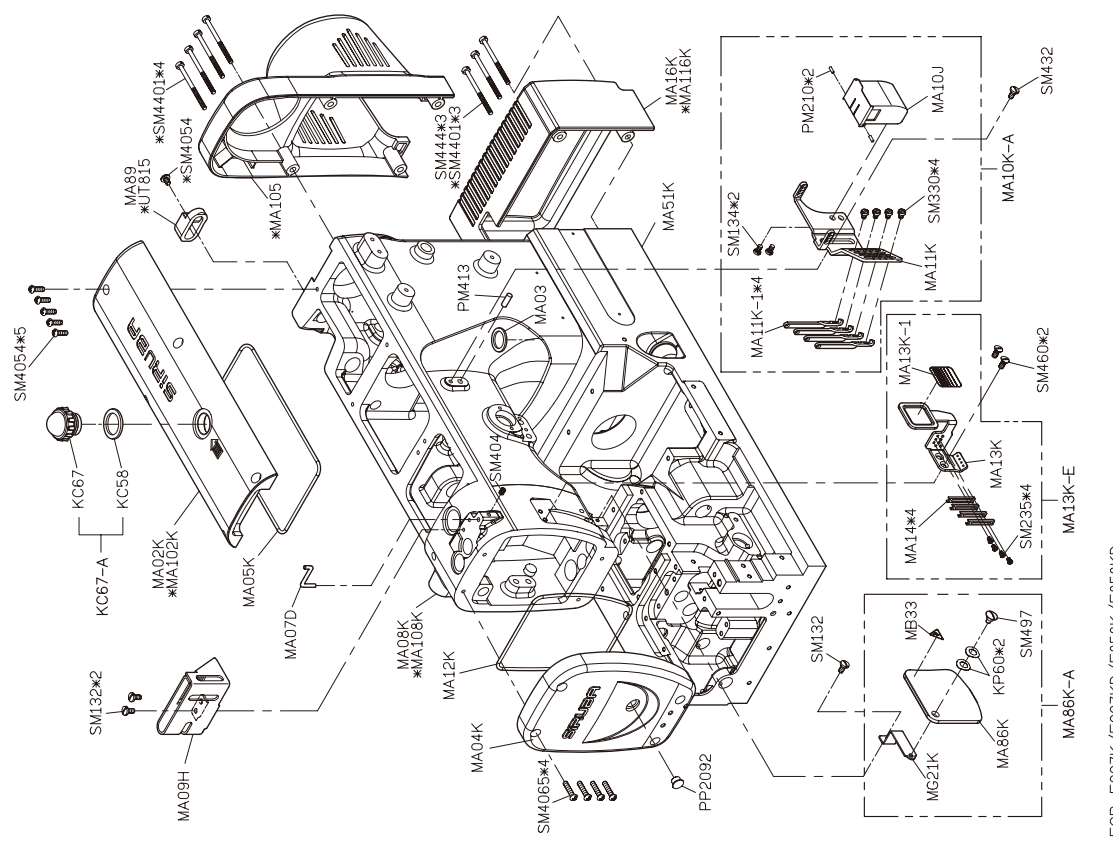

FOR F007K/F007KD/F858K/F858KD
*USR FOR F007KD/F858KD

FOR F007K/F007KD/F858K/F858KD

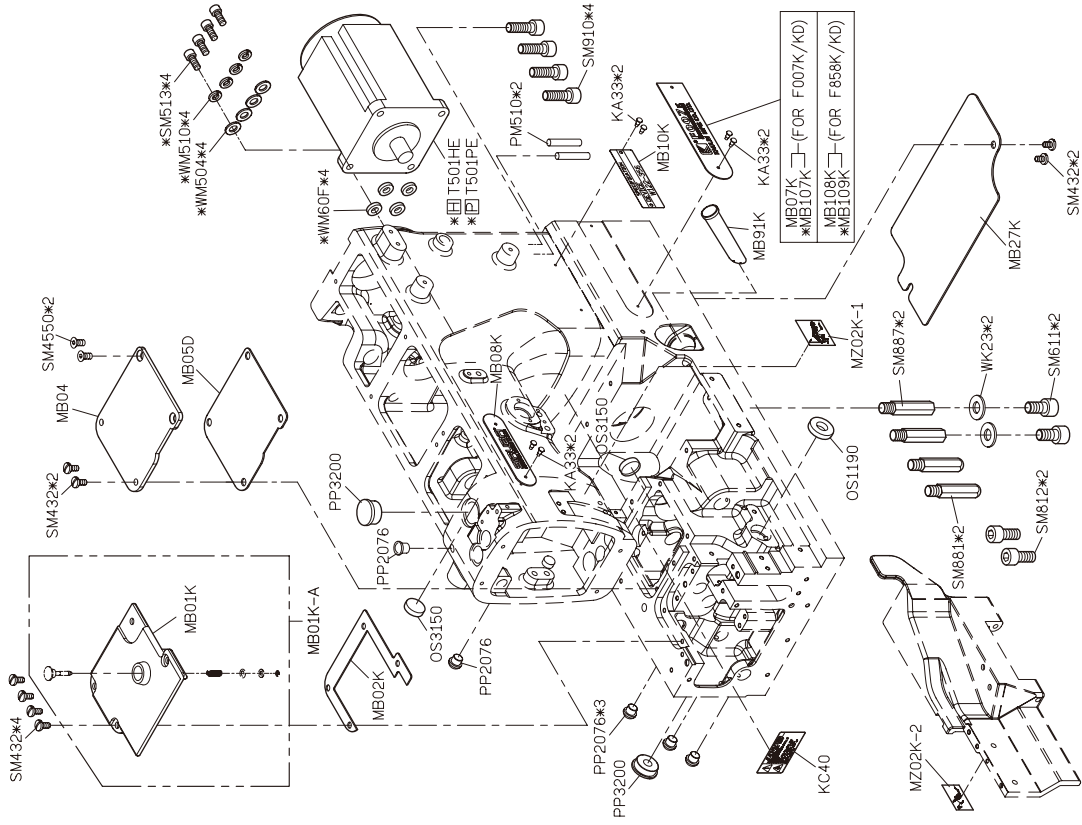

FOR F007K/F007KD/F858K/F858KD
 *USE FOR F007KD/F858KD

□ FOR F007KD H牌組裝
 □ FOR F007KD P牌組裝

PARTS LIST FOR MB GROUP

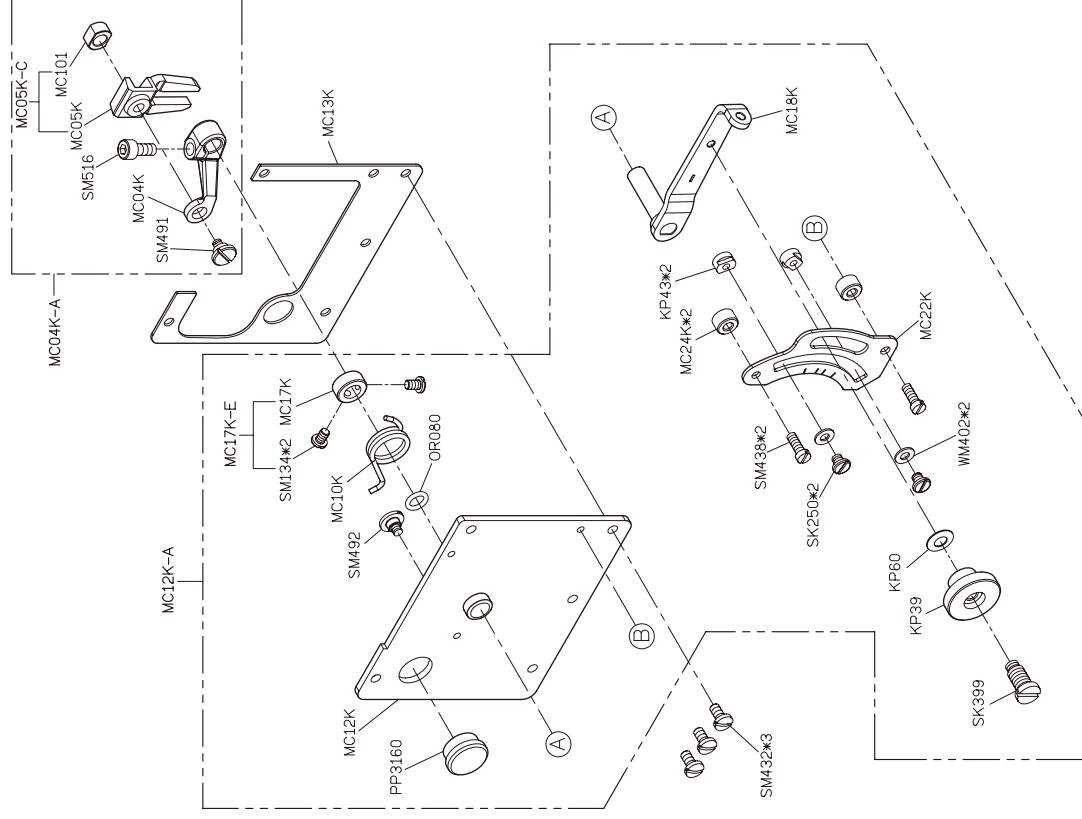

FOR F007K/F007KD/F858K/F858KD

PARTS LIST FOR MC GROUP

PARTS LIST FOR MG GROUP

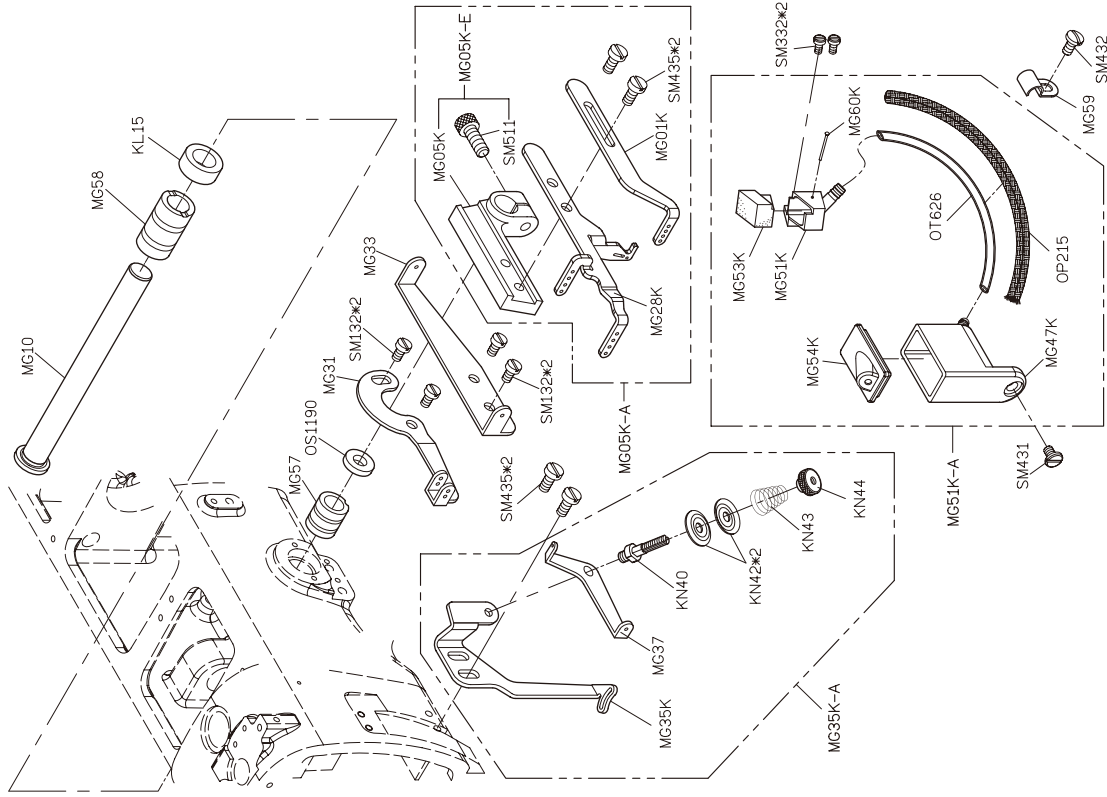

FOR F007K/F007KD/F858K/F858KD

PARTS LIST FOR MH GROUP

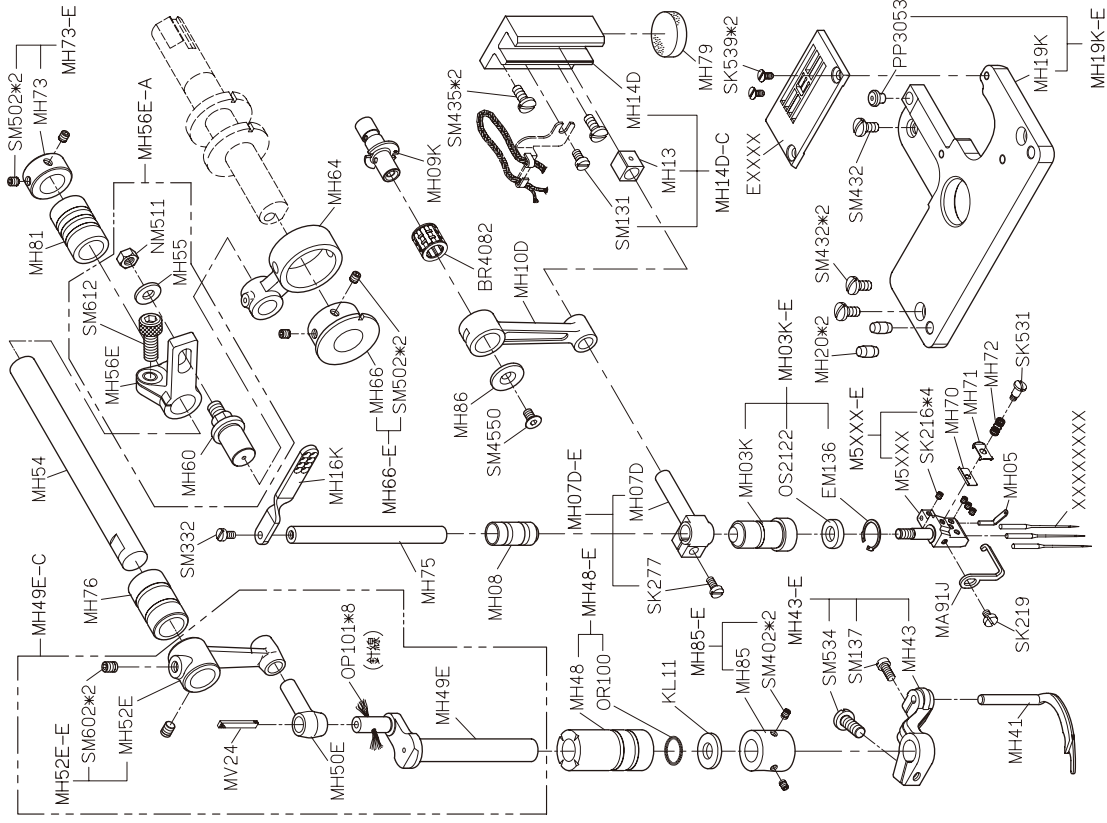

FOR F007K/F007KD/F858K/F858KD

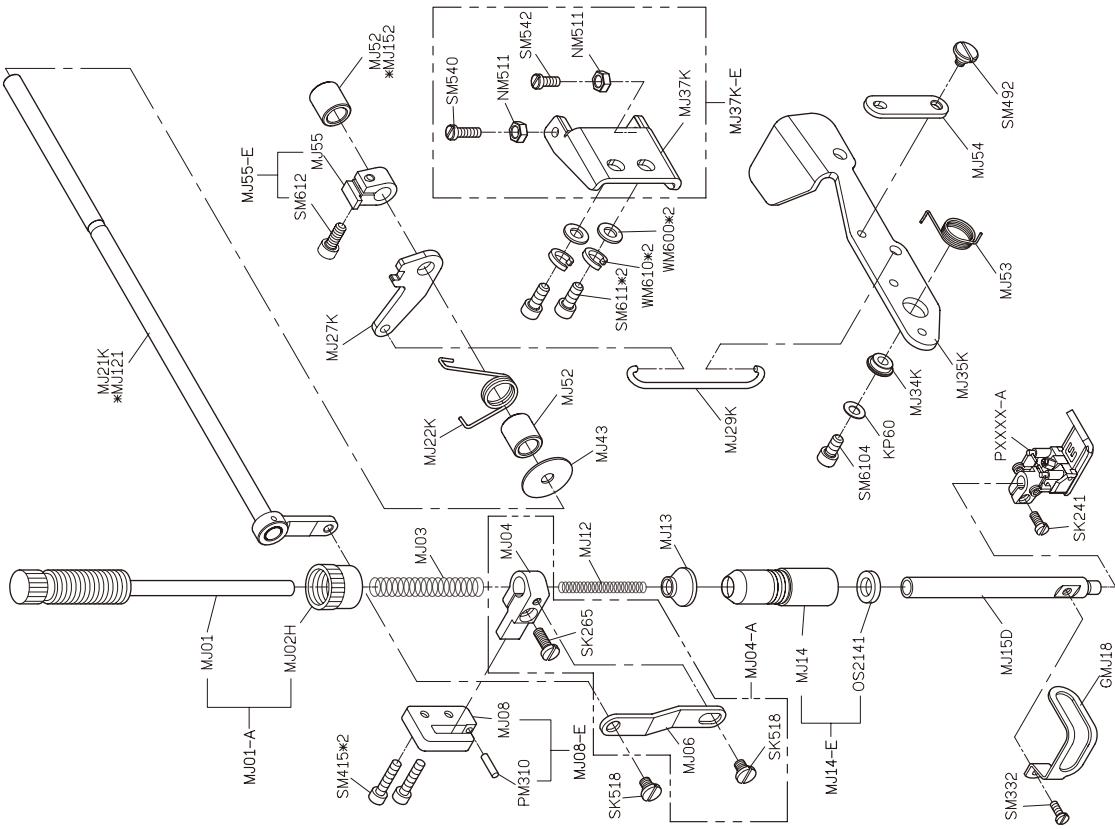

FOR F007K/F007KD/F858K/F858KD
 *USE FOR F007KD/F858KD

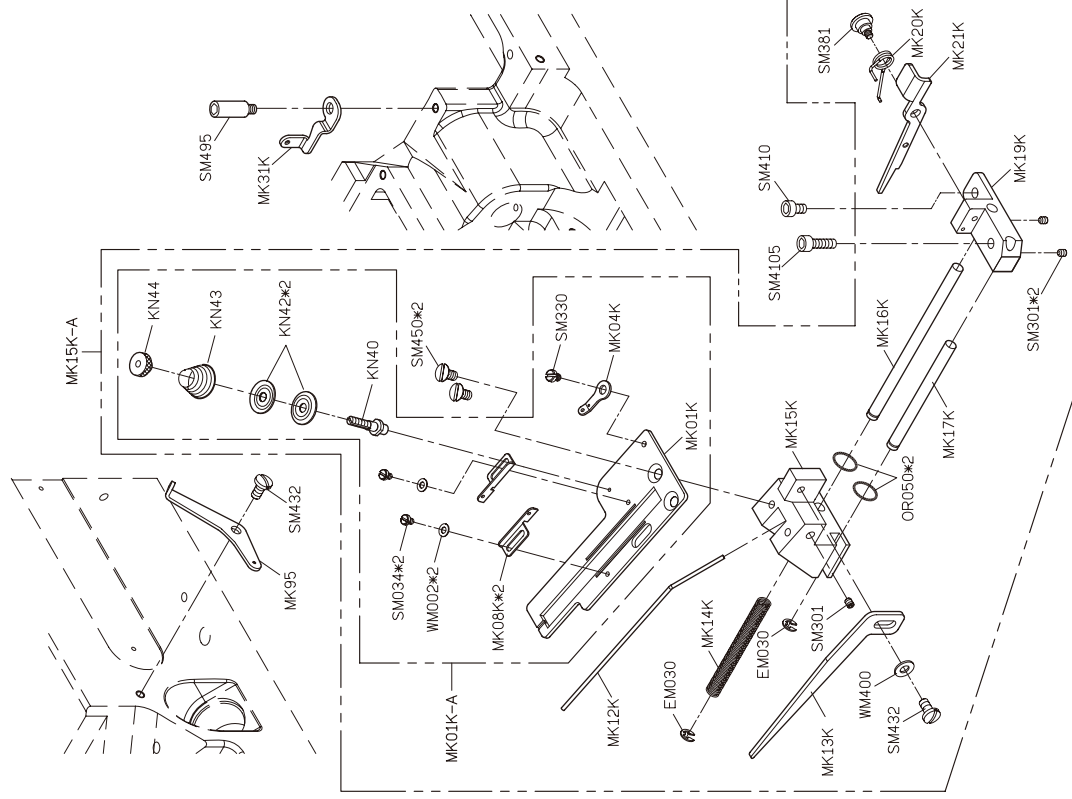

FOR F007K/F007KD/F858K/F858KD

PARTS LIST FOR MJ GROUP

PARTS LIST FOR MK GROUP

PARTS LIST FOR MK GROUP

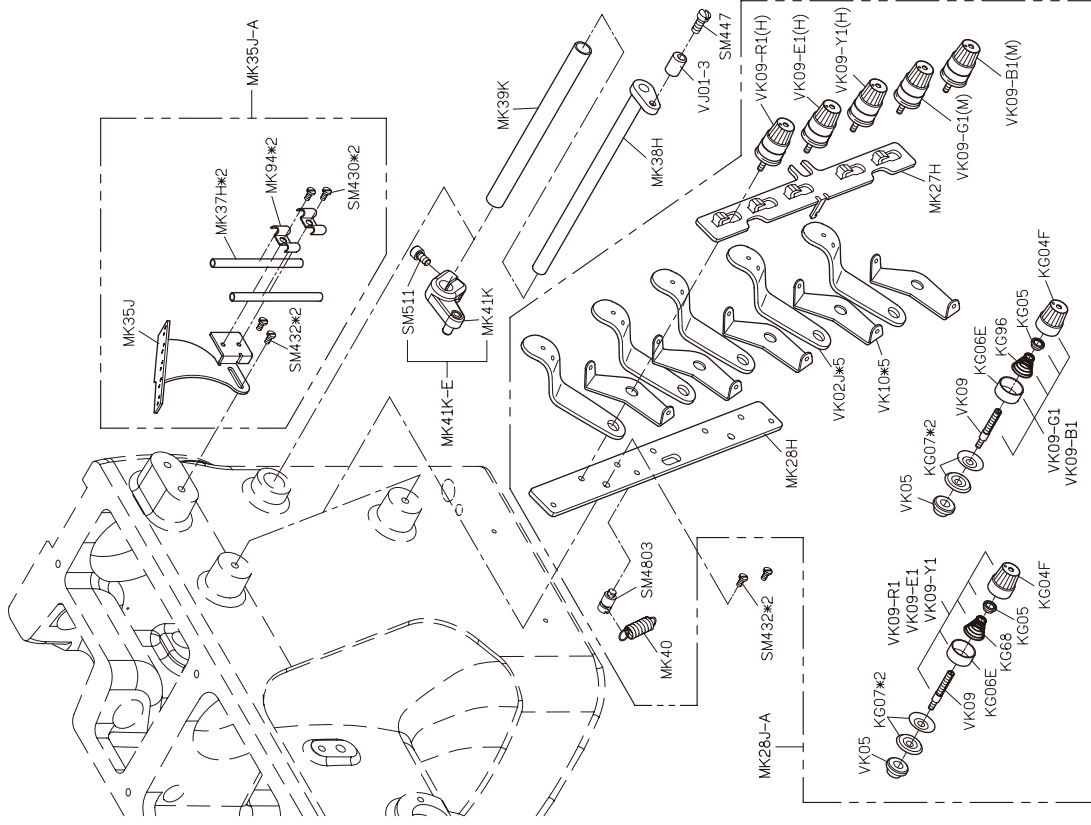

FOR F007K/F007KD/F858K/F858KD

PARTS LIST FOR ML GROUP

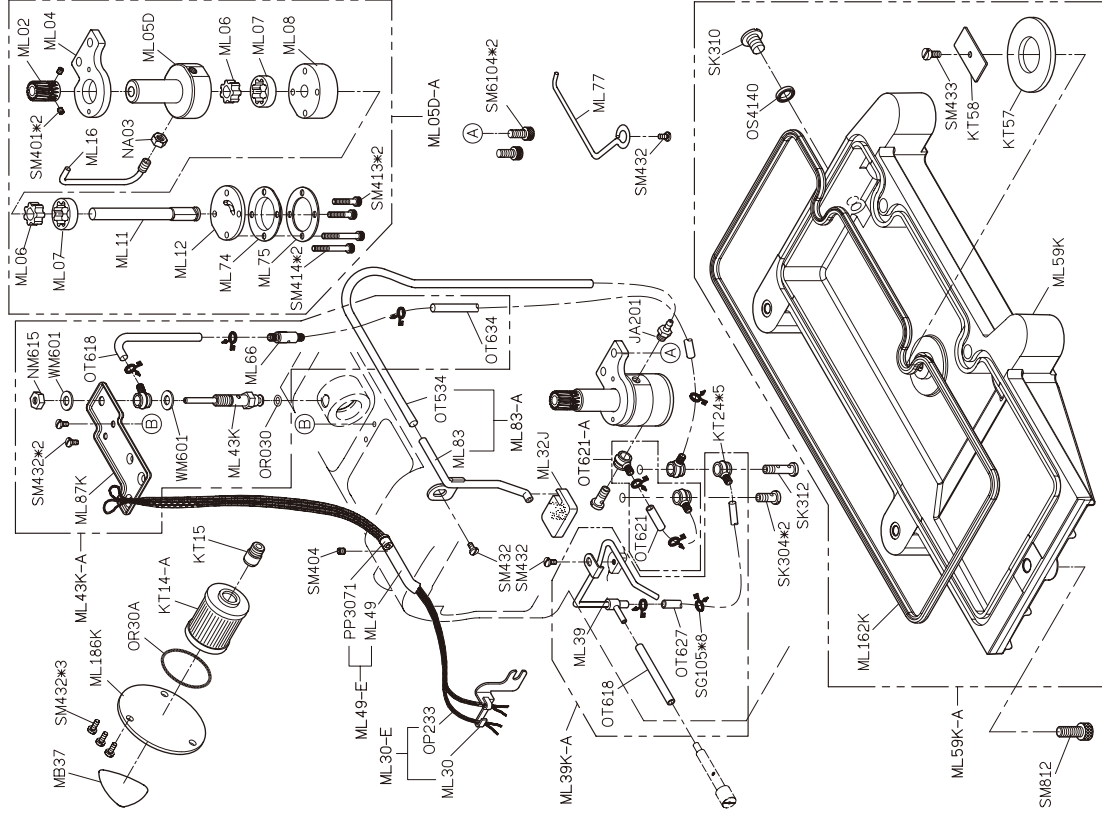

FOR F007K/F007KD/F858K/F858KD

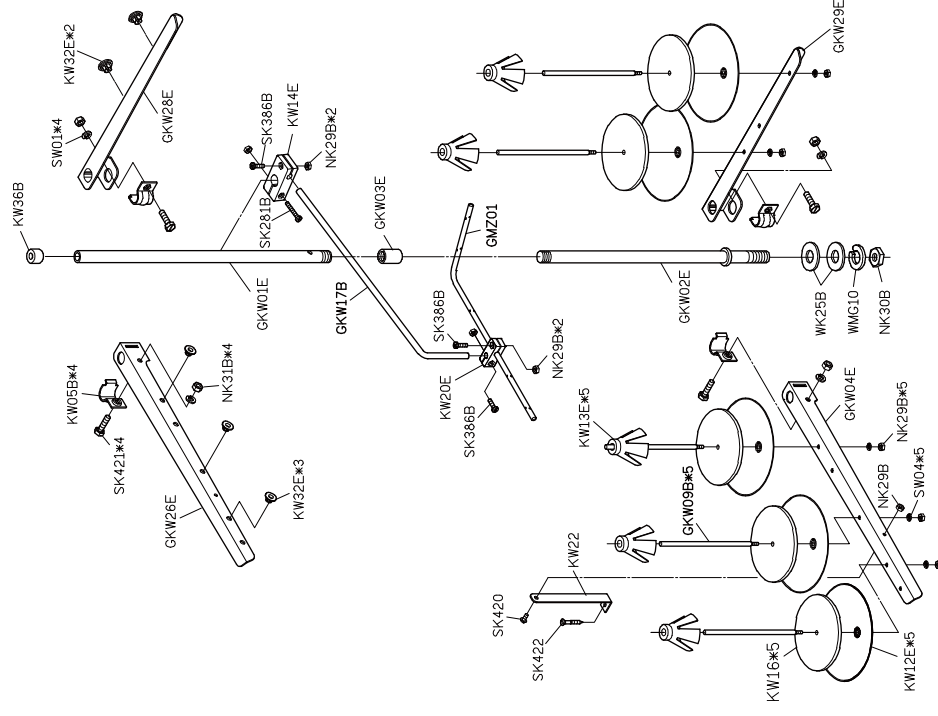
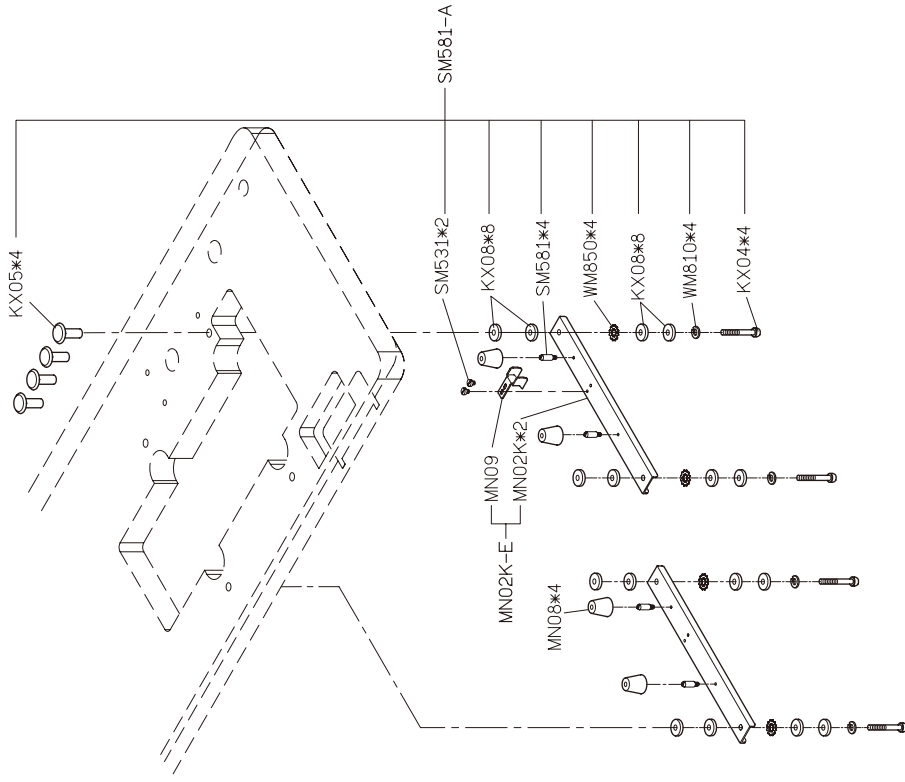

FOR F007K/F007KD/F858K/F858KD

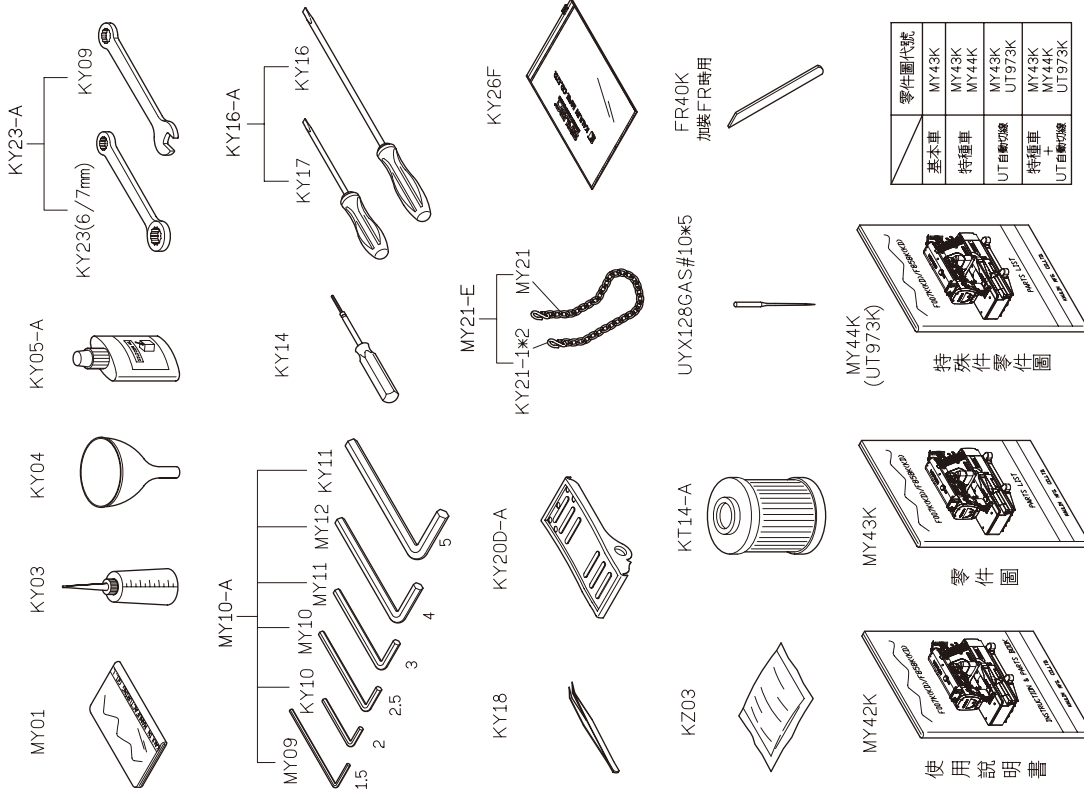

FOR F007K/F007KD/F858K/F858KD

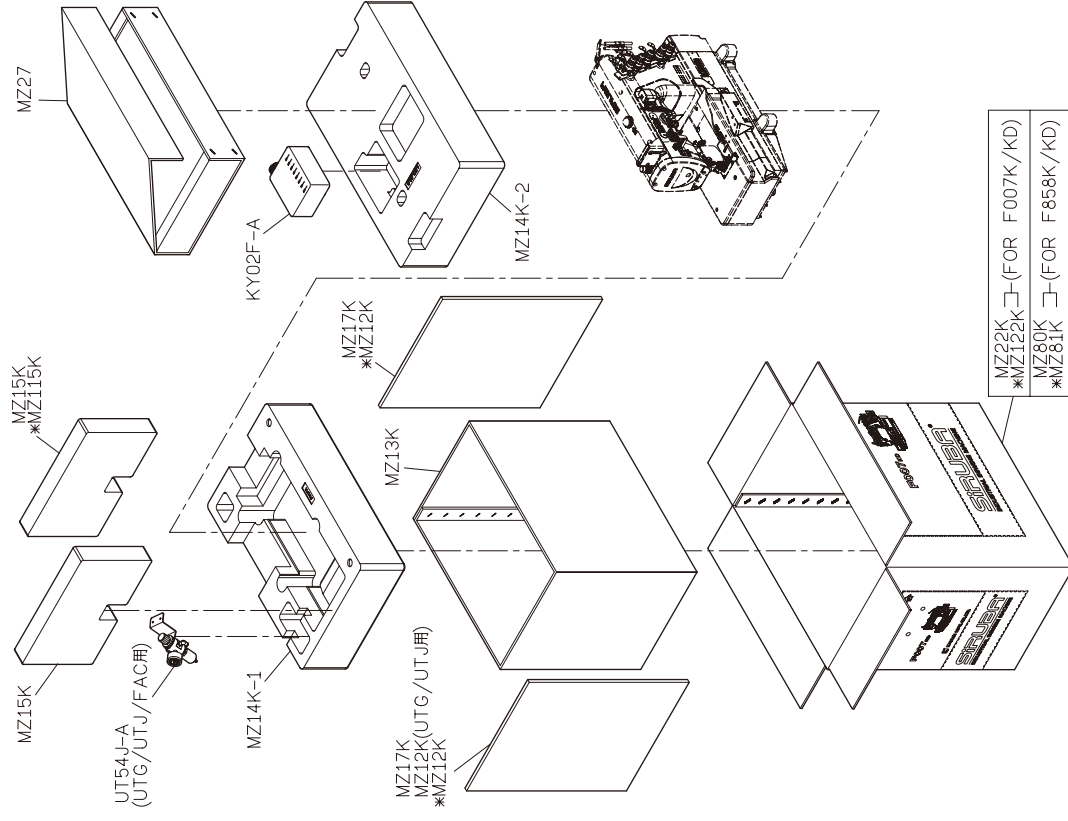

FOR F007K/F007KD/F858K/F858KD
*USE FOR F007KD/F858KD

FOR FHA TYPE

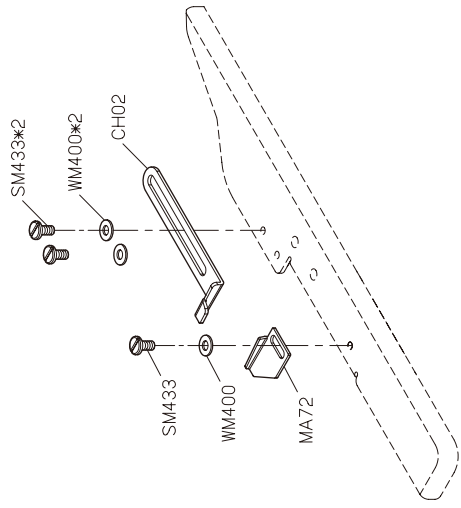

FOR FHA/FQ TYPE

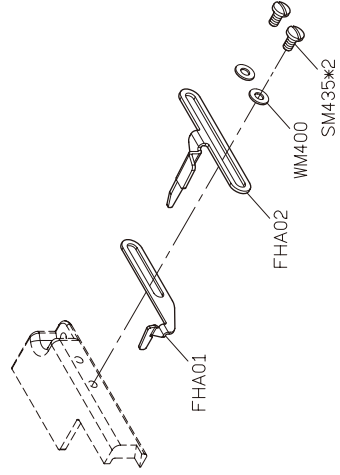

FOR F007K/F007KD/F858K/F858KD

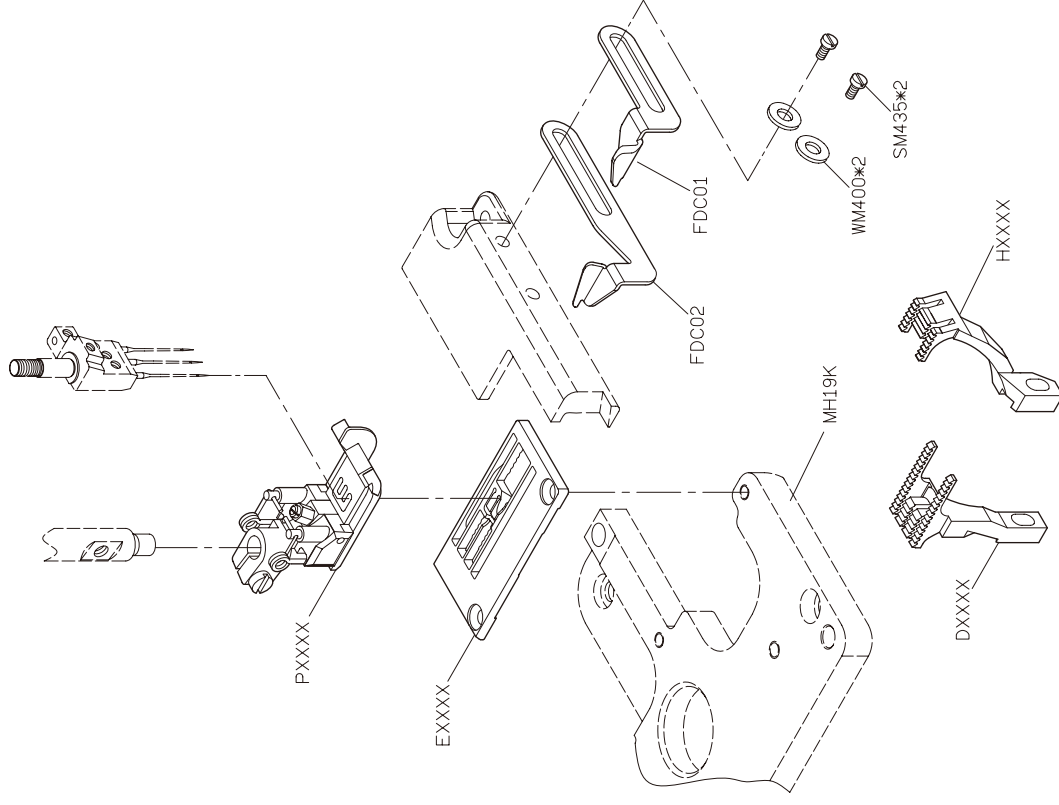

FOR F007K/F007KD/F858K/F858KD

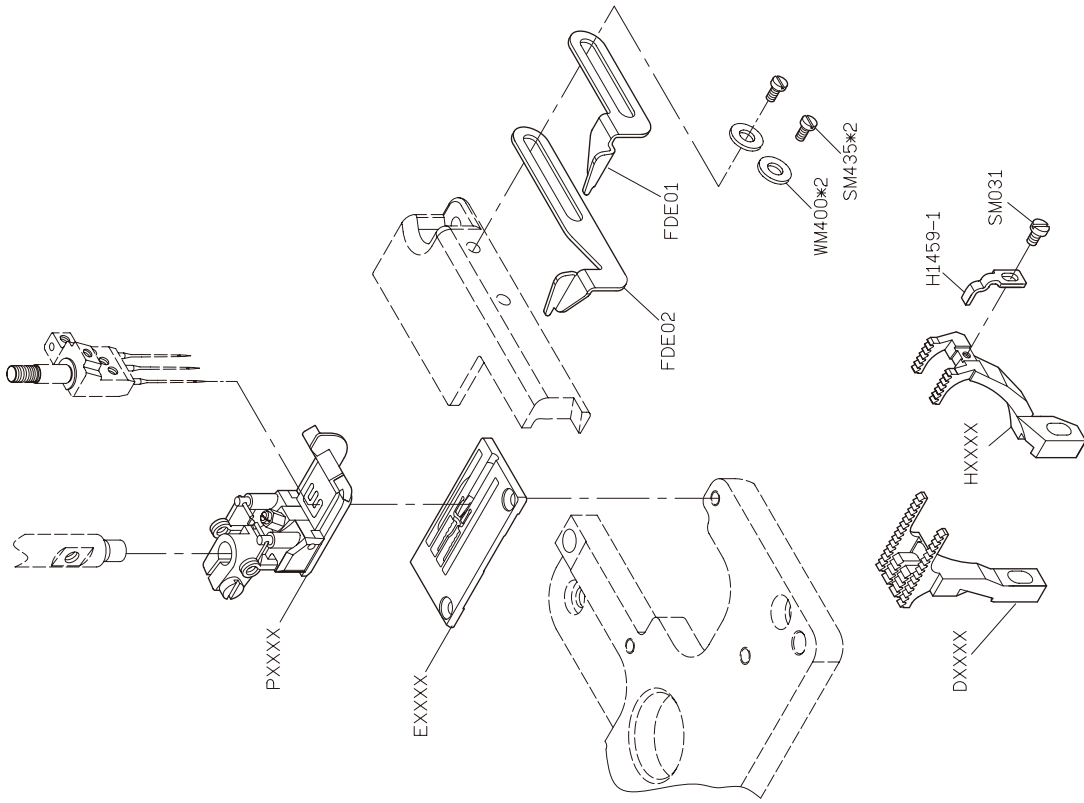

FOR F007K/F007KD/F858K/F858KD



F007K / F007KD
F858K / F858KD

高林股份有限公司 KAULIN MFG. CO., LTD.